





BiMobile Dual Mobility System

Uncemented & Cemented

| Explanation of Pictograms | | | |
|---|-----------------|---|--|
|  | Manufacturer |  | Article number |
|  | Material number | Rx only | Caution: Federal law restricts this device to sale by or on the order of a physician |

BiMobile Dual Mobility System

Uncemented & Cemented

Surgical Technique

- 02 Preoperative Planning
- 03 Preparation and Implantation
- 04 Implantation of the Shell
- 06 Uncemented Shell
- 07 Cemented Shell
- 08 Trial Reduction, Option 1
- 09 Trial Reduction, Option 2
- 10 Assembly of Prosthesis Head and Liner
- 11 Impaction of assembled Prosthesis Head and Liner, Final Reduction, Removal of the Shell, Removal of the Liner

Implants

- 12 BiMobile Dual Mobility System – Shells, Cemented
- 13 BiMobile Dual Mobility System – TiCaP Shells, Uncemented
- 14 BiMobile Dual Mobility System – Liner, UHMWPE
- 15 BiMobile Dual Mobility System – Liner, E-Dur

Instruments

- 16 Basic Instruments for BiMobile Dual Mobility System, Option 1
- 17 Instrument Set 1 for BiMobile Dual Mobility System
- 18 Instrument Set 2 (Option 1) for BiMobile Dual Mobility System
- 19 Instrument Set 2 (Option 2) for BiMobile Dual Mobility System
- 20 Instrument Set for LINK Acetabular Reamers
- 21 Instrument Set for LINK Acetabular Reamers

Additional Instruments - Accessories

- 22 Additional Instruments
- 22 X-ray Templates

Indications/Contraindications

- 23 Indications/Contraindications

- 24 **Notes**

Important Information

Preoperative Planning

It is important to plan the intervention preoperatively in order to select the correct implant type and size and its final intraosseous position based on the patient's individual anatomy. The surgeon should perform a careful evaluation of the patient's clinical condition and consider the level of physical activity before performing a hip replacement.

For optimal results, the surgery should be planned in advance using the appropriate templates. The magnification factor of the X-rays must be compatible with the factor on the templates. Special BiMobile Dual Mobility System X-ray templates are available in standard 1.1:1.

The implant size must be chosen from adequate AP and ML X-rays with sufficient legibility. Each X-ray should be large enough for application of the whole template. A second X-ray of the unaffected joint is often helpful. Inadequate preoperative planning can lead to improper selection of the implants and/or incorrect implant positioning.

INFORMATION:

Preoperative planning provides an initial estimation of the final situation but cannot conclusively determine the most adequate size to be used. The ultimate decision can only be made intraoperatively.

In principle, a load-bearing, stable acetabular fossa and solid lateral osseous coverage is desirable. To achieve a press-fit with primary stability, the osseous circumference of the acetabulum must be well preserved.

The **inclination** of the cup should not be significantly above or below 45°. The **anteversion** should not be significantly above or below 15°.

Placement outside of these boundaries will result in reduced range of motion and could subsequently lead to subluxation and/or dislocation of the joint.

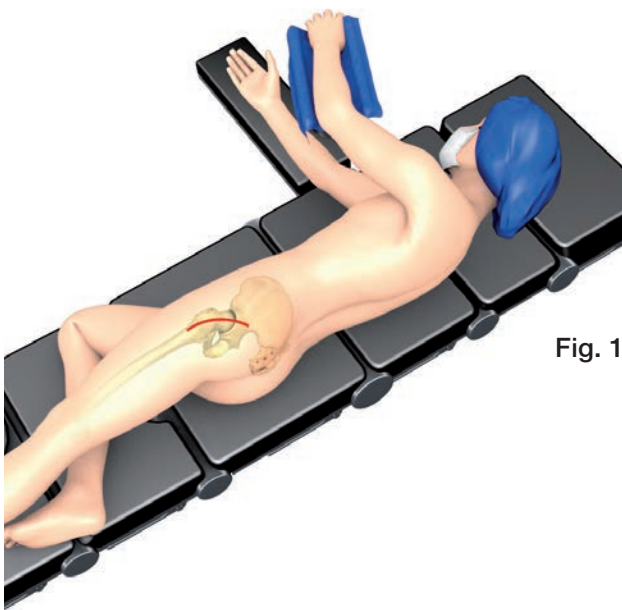

Fig. 1

Preparation and Implantation

Surgical Exposure

The BiMobile Dual Mobility System can be implanted using any of the standard approaches for total hip replacement depending on the surgeon's experience (Fig. 1).

Acetabular Reaming

Depending on the approach used, the leg is positioned such that the acetabulum is well exposed.

The initial reamer size corresponds to the width of the acetabular cup entrance. In normal anatomy the reamer is inserted into the acetabulum at approximately 45 degrees inclination and 15 degrees anteversion (Fig. 2).



Fig. 2

Consecutive reamers with increasing diameters are applied until areas of bloody subchondral bone become visible but without compromising the supportive structure for secure anchoring of the Shell. It is essential to keep the reamer head absolutely steady.



Fig. 3

Determination of Shell Size

Following preparation of the acetabulum, the Trial Cup is attached to the Impactor Handle [183-150/03](#) (Fig. 3) and is inserted into the acetabulum.



Fig. 4

The Trial Cup is used to determine the size of the Shell as the reamed cavity may be larger than originally intended. When the trial is firmly seated in the reamed acetabulum, select the corresponding Shell. (Fig. 4).

Implantation of the Shell

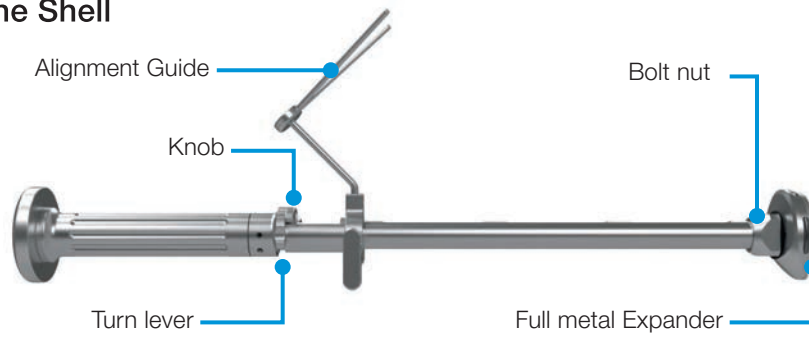

Fig. 5

Take the Impactor Handle [184-334/00](#) and place the full metal Expander on the rectangular rod on the bottom of the handle. Direct the Expander in such a way you need it for your surgical approach. The straight side is directed towards the incisura acetabuli (Fig. 5).



Fig. 6

INFORMATION:

Select the Impaction Expander corresponding to the Shell size to be implanted. Follow the color coding.



Fig. 7

Push the full metal Expander in the final position and close the bolt nut (Fig. 6).

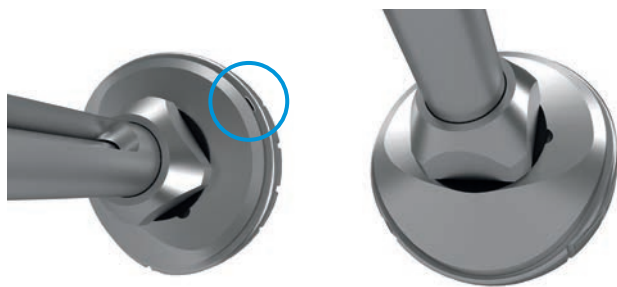

Fig. 8

To connect the Shell to the Impactor Handle pull the knob at the Handle. Make sure the small turn lever is in an opened position (Fig. 7).

Align the medioventral cutout of the Shell with the bevel of the Expander, which also has a small nose that is directed into the notch of the Shell (Fig. 8).

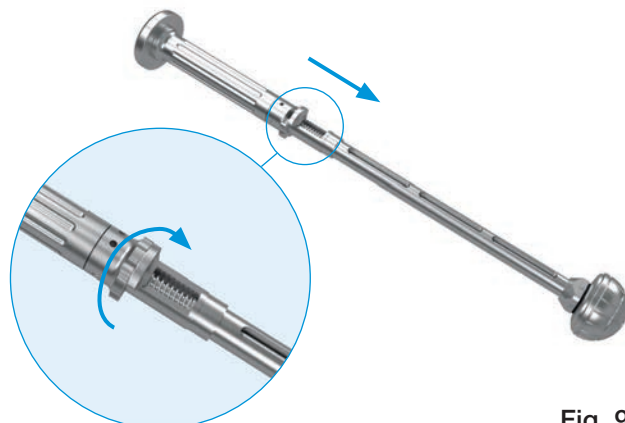

Fig. 9

After final positioning of the Shell onto the full metal Expander release the knob and the Shell is firmly connected.

For additional securement before using the hammer for insertion into the acetabulum, the turn lever has to be closed. Turn this lever into the locked position so the knob cannot be used (Fig. 9).

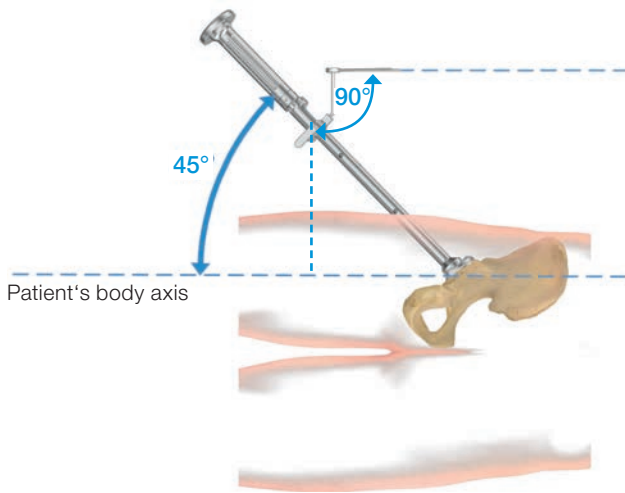

Fig. 10

An alignment of the Shell is necessary for the perfect seating of the Shell. To achieve 45° inclination the Impactor Handle 184-334/00 should be 45° to the patient's body axis – dorso-ventral view (Fig. 10). To achieve 15° anteversion the Impactor Handle 184-334/00 is oriented such that the Handle is 15° to the patient's body axis – medio-lateral view (Fig. 10).

Optional an Alignment Guide is available for an easier orientation. If an Alignment Guide is used please follow the next steps on this side. If not proceed with next page.

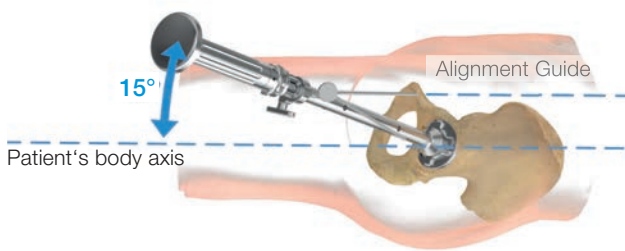

Fig. 11

The Shell is aligned at 45° inclination using the corresponding Alignment Guide 184-335/00 which is attached to the Impactor Handle 184-334/00. The Alignment Guide 184-335/00 should be 90° to the body axis (Fig. 10). To achieve 15° anteversion the Impactor Handle 184-334/00 is oriented such that the Alignment Guide 184-335/00 is in parallel to the patient's body (Fig. 11).

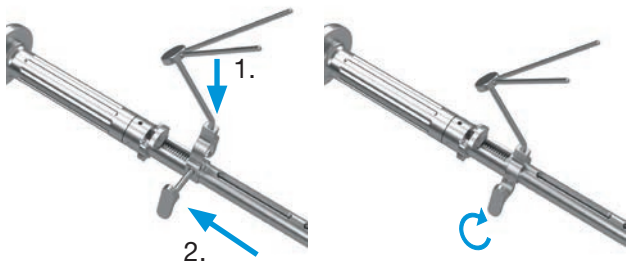

Fig. 12

Attach the Alignment Guide 184-335/00 to the Impactor Handle 184-334/00 so that the Alignment Guide 184-335/00 aligns exactly in the direction of the marker on the Impaction Expander. For this the Alignment Guide 184-335/00 is put on the Impactor Handle 184-334/00 (1.), slid back (2.) and is then fixed by tightening the screw.

According to the patient's side to be treated, take the prevailing rod (L = left side or R = right side) for guidance (Fig. 12).



Fig. 13

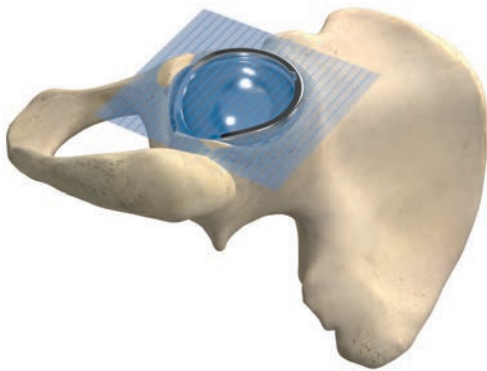

Fig. 14

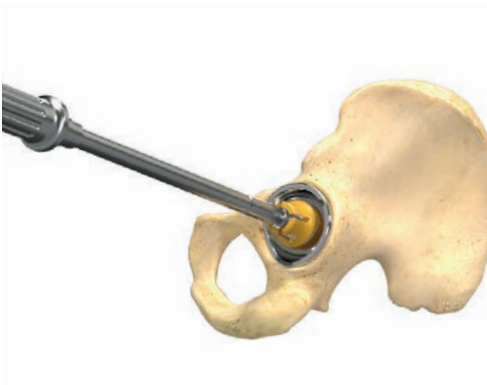

Fig. 15



Fig. 16

Uncemented Shell



The Uncemented Shells are designed with a built-in equatorial press-fit of ~2 mm, e.g. Shell size: 52 mm → actual size: 54 mm. The intraoperative press-fit depends on the last used Acetabular Reamer as shown in the table below.

| Shell size on label | Last Reamer used | Equatorial Press-fit |
|---------------------|------------------|----------------------|
| 52 mm | 52 mm | 2 mm |
| 52 mm | 53 mm | 1 mm |

INFORMATION:

Appropriate reaming should be based upon the patient's bone quality as determined by the surgeon intraoperatively.

INFORMATION:

Position the Shell such that the medioventral cutout aligns with the incisura acetabuli.

The Shell is then driven with appropriate taps on the Impactor Handle 184-334/00 into the prepared acetabulum (Fig. 13).

The equator (border of polished rim) of the Shell should be parallel to the acetabulum entrance plane for secure seating in the surrounding bone (Fig. 14).

If the shell is not positioned well after loosening the Impactor Handle 134-334/00 it is possible to connect the handle again or to follow the steps described below:

The Final Shell Impactor 183-135/10 is mounted on the Impactor Handle 183-150/03 (Fig. 15) in order to drive the Shell into the final position by impacting the Shell home.

Before final impaction the alignment of the Shell may be adjusted by using the Rim Impactor. For this purpose the Rim Impactor 184-135/10 is mounted on the Impactor Handle 183-150/03 (Fig. 16).

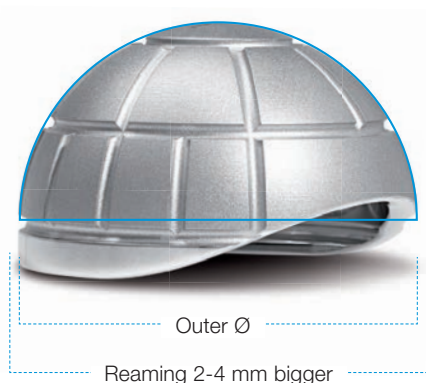

Cemented Shell

Inserting anchoring holes for bone cement primarily in the load-bearing zone of the acetabulum is recommended.

To enable a sufficiently thick cement mantle, the final implant is to be selected 2-4 mm smaller than the last applied Acetabular Reamer Head.



Fig. 17

Following the application of the cement, the Cemented Shell is to be inserted into the prepared implant bed using the Impactor Handle 184-334/00 with the Impaction Expander mounted as described in the prior section. The excess cement has to be removed (Fig. 17).

INFORMATION:

Remove any cement from the Impaction Expander and its through holes while the cement is still pliable to facilitate cleaning.



Fig. 18

Once the Shell is in its desired position, disconnect the Impactor Handle 184-334/00.

The alignment of the Shell may be adjusted by using the Rim Impactor, but only as long as the cement is still pliable. For this purpose, the Rim Impactor 184-135/10 is mounted on the Impactor Handle 183-150/03.

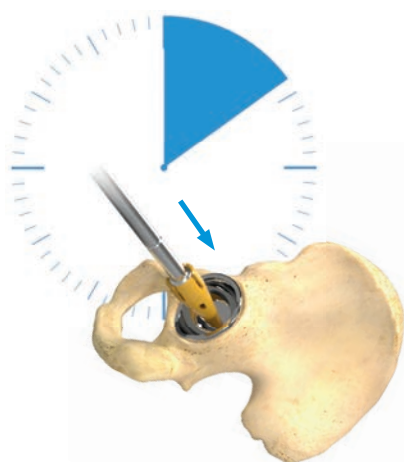

Fig. 19

The Shell Pusher 184-135/12 is mounted on the Impactor Handle 183-150/03 (Fig. 18).

While the cement hardens, the BiMobile Dual Mobility Shell is held in position with the Shell Pusher. The design of Shell Pusher prevents the transmission of the surgeon's movements to the implant (Fig. 19).

During the hardening process of the cement, the excess cement has to be removed.

The following steps are identical to the surgical technique of the Uncemented Shell.

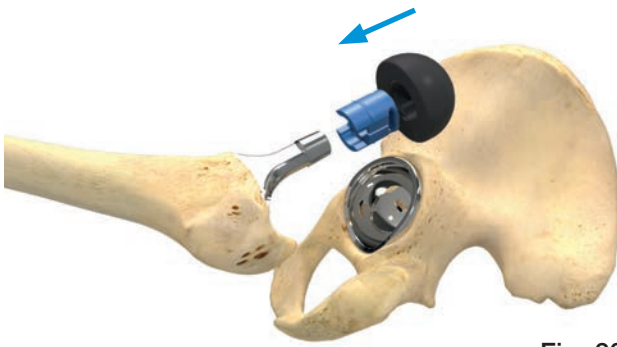

Fig. 20

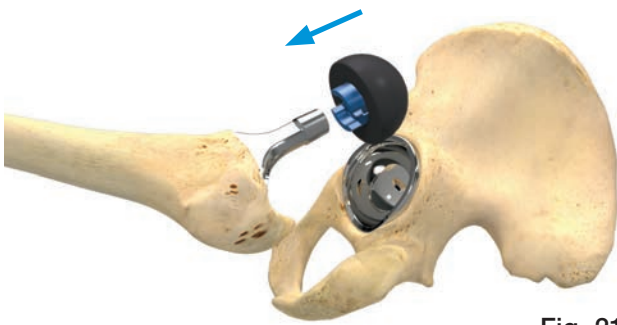

Fig. 21



Fig. 22

Trial Reduction

Option 1

Select the appropriate Plastic Trial Sleeve and seat it inside the Trial Liner that corresponds to the implanted shell size which is also supported by a color coding (Fig. 20). The length of the Trial Sleeve should correspond to the head neck length of the Prosthesis Head.

INFORMATION:

Implant identification must be made using laser marked information. Color coding is used only as a secondary reference. There may be slight variations in colors between components.

Place the assembled Trial Liner and Sleeve onto the broach from the stem system or on final femoral implant (Fig. 21).

After reduction of the joint, the leg length, joint stability and range of motion is checked (Fig. 22).

INFORMATION:

Prosthesis stems with classic long taper and/or unfavorable neck design can reduce the range of motion.

INFORMATION:

In case the modular Trial Neck of the femoral implant system is stuck in the Plastic Trial Sleeve use the Disassembly Support as shown in Fig. 23.

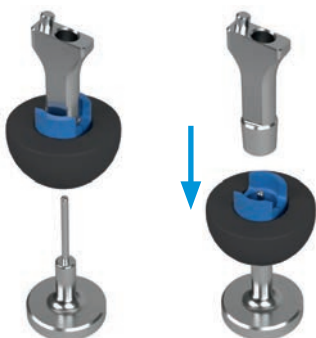

Fig. 23

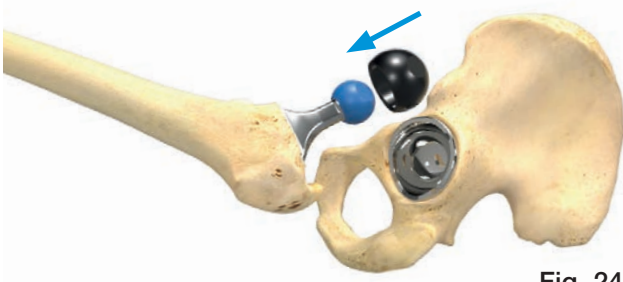

Fig. 24

Option 2

Select the appropriate Plastic Trial Head and place it onto the femoral rasp from the stem system or on the final femoral implant (Fig. 24).

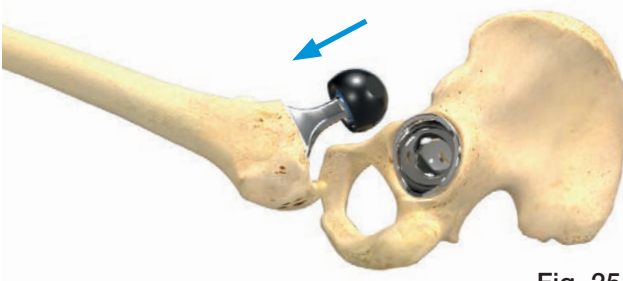

Fig. 25

Place the Trial Liner that corresponds to the implanted shell size which is supported by a color coding onto the Plastic Trial Head (Fig. 25).

INFORMATION:

The inner diameter of the Trial Liner is adjusted to Ø 28 mm. The final size of the Prosthesis Head may differ from the Plastic Trial Head. This will not affect the range of motion nor the head neck length of the implant.

INFORMATION:

Implant identification must be made using laser marked information. Color coding is used only as a secondary reference. There may be slight variations in colors between components.



Fig. 26

After reduction of the joint, the leg length, joint stability and range of motion is checked (Fig. 26).

INFORMATION:

Prosthesis stems with classic long taper and/or unfavorable neck design can reduce the range of motion.

Assembly of Prosthesis Head and Liner



Fig. 27

Place the Base on the instrumentation table.

Slide the Press into the Base (Fig. 27).



Fig. 28

Mount the Adapter Base for Prosthesis Head onto the Press (Fig. 28).

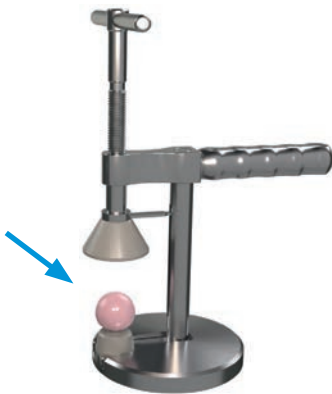

Fig. 29

Place the Femoral Head on the Adapter Base for Prosthesis Head (Fig. 29).

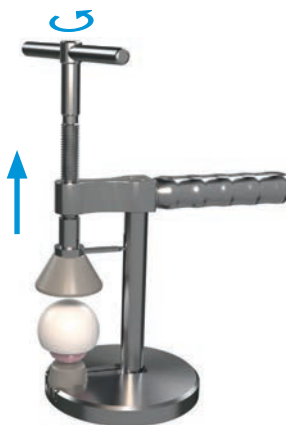

Fig. 30

Open the Press completely by rotating the press handle counterclockwise. Position and place the Liner on the Head (Fig. 30).



Fig. 31

Rotate the press handle clockwise until the Liner is forced onto the Head (Fig. 31).

A distinctive “pop” sound should be heard.



Fig. 32

Once this sound is heard, rotate the press handle counterclockwise to open the Press (Fig. 32).

Check whether the Femoral Head rotates freely in the Liner. If the Head does not rotate freely use the Press again.



Fig. 33

Impaction of assembled Prosthesis Head and Liner

Place the assembled Prosthesis Head and Liner on the cleaned taper of the femoral stem and fix it with a light tap on the Head Impactor (Fig. 33).



Fig. 34

Final Reduction

Reduce the assembled Prosthesis Head and Liner into the cleaned Shell with help of the Head Impactor (Fig. 34).

Check for joint stability and range of motion (Fig. 35).

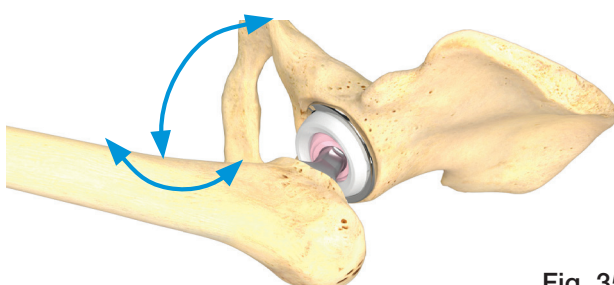

Fig. 35

Removal of the Shell

If the Shell has to be revised, loosen the peripheral fixation with an osteotome. Remove the Shell manually.

INFORMATION:

Do not use the Impactor Handle with attached Impaction Expander to revise the Shell.

Removal of the Liner

The Liner cannot be removed separately. Instead remove the assembled Prosthesis Head and Liner from the femoral implant.

BiMobile Dual Mobility System – Shells, Cemented



Shell, Cemented

MAT EndoDur (CoCrMo alloy)

| Shell REF | Outer Ø mm |
|---------------------|---------------|
| 184-001/42 | 42 |
| 184-001/44 | 44 |
| 184-001/46 | 46 |
| 184-001/48 | 48 |
| 184-001/50 | 50 |
| 184-001/52 | 52 |
| 184-001/54 | 54 |
| 184-001/56 | 56 |
| 184-001/58 | 58 |
| 184-001/60 | 60 |
| 184-001/62 | 62 |
| 184-001/64 | 64 |
| 184-001/66 | 66 |
| 184-001/68 | 68 |
| 184-001/70 | 70 |

BiMobile Dual Mobility System – Shells, Uncemented



TiCaP Shell, Uncemented

MAT EndoDur (CoCrMo alloy),

TiCaP Double Coating

(Titanium Plasma Spray / calcium phosphate CaP)

| Shell REF | Outer Ø mm |
|---------------------|---------------|
| 184-101/42 | 42 |
| 184-101/44 | 44 |
| 184-101/46 | 46 |
| 184-101/48 | 48 |
| 184-101/50 | 50 |
| 184-101/52 | 52 |
| 184-101/54 | 54 |
| 184-101/56 | 56 |
| 184-101/58 | 58 |
| 184-101/60 | 60 |
| 184-101/62 | 62 |
| 184-101/64 | 64 |
| 184-101/66 | 66 |
| 184-101/68 | 68 |
| 184-101/70 | 70 |

BiMobile Dual Mobility System – Liner



Liner

MAT UHMWPE

| Liner REF | Inner Ø mm | For Shell Ø mm |
|---------------------|------------|----------------|
| 184-250/01 | 22 | 42 |
| 184-250/02 | 22 | 44 |
| 184-250/03 | 22 | 46 |
| 184-260/01 | 28 | 48 |
| 184-260/02 | 28 | 50 |
| 184-260/03 | 28 | 52 |
| 184-260/04 | 28 | 54 |
| 184-260/05 | 28 | 56 |
| 184-260/06 | 28 | 58 |
| 184-260/07 | 28 | 60 |
| 184-260/08 | 28 | 62 |
| 184-260/09 | 28 | 64 |
| 184-260/10 | 28 | 66 |
| 184-260/11 | 28 | 68 |
| 184-260/12 | 28 | 70 |

BiMobile Dual Mobility System – Liner

E-Dur (Vitamin E blended Highly Crosslinked UHMWPE)



Liner

MAT E-Dur (Vitamin E blended Highly Crosslinked UHMWPE)

| Liner REF | Inner Ø mm | For Shell Ø mm |
|---------------------|------------|----------------|
| 184-270/01 | 22 | 42 |
| 184-270/02 | 22 | 44 |
| 184-270/03 | 22 | 46 |
| 184-280/01 | 28 | 48 |
| 184-280/02 | 28 | 50 |
| 184-280/03 | 28 | 52 |
| 184-280/04 | 28 | 54 |
| 184-280/05 | 28 | 56 |
| 184-280/06 | 28 | 58 |
| 184-280/07 | 28 | 60 |
| 184-280/08 | 28 | 62 |
| 184-280/09 | 28 | 64 |
| 184-280/10 | 28 | 66 |
| 184-280/11 | 28 | 68 |
| 184-280/12 | 28 | 70 |

184-110/05 Basic Instruments for BiMobile Dual Mobility System,
Option 1 (Impactor Handle)

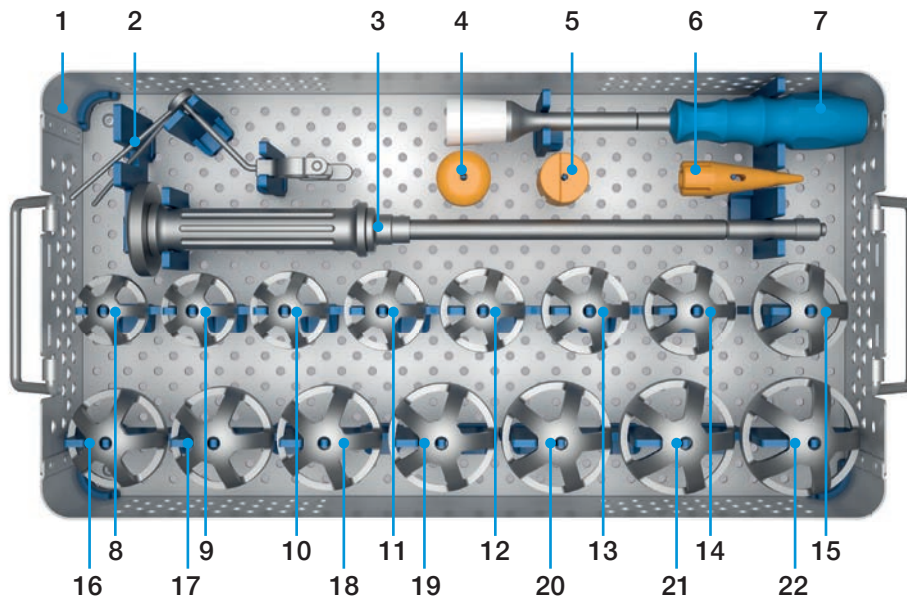

| | REF | Description |
|----|------------|---|
| 1 | 184-110/15 | Instrument Tray, empty |
| 2 | 184-335/00 | Alignment Guide* for Impactor Handler 184-334/00 |
| 3 | 183-150/03 | Impactor Handle |
| 4 | 183-135/10 | Final Shell Impactor |
| 5 | 184-135/10 | Rim Impactor for Handle 183-150/03 |
| 6 | 184-135/12 | Shell Pusher |
| 7 | 175-360 | Head Impactor, with exchangeable plastic head, L = 242 mm |
| 8 | 183-135/42 | Trial Cup, Ø 42 mm |
| 9 | 183-135/44 | Trial Cup, Ø 44 mm |
| 10 | 183-135/46 | Trial Cup, Ø 46 mm |
| 11 | 183-135/48 | Trial Cup, Ø 48 mm |
| 12 | 183-135/50 | Trial Cup, Ø 50 mm |
| 13 | 183-135/52 | Trial Cup, Ø 52 mm |
| 14 | 183-135/54 | Trial Cup, Ø 54 mm |
| 15 | 183-135/56 | Trial Cup, Ø 56 mm |
| 16 | 183-135/58 | Trial Cup, Ø 58 mm |
| 17 | 183-135/60 | Trial Cup, Ø 60 mm |
| 18 | 183-135/62 | Trial Cup, Ø 62 mm |
| 19 | 183-135/64 | Trial Cup, Ø 64 mm |
| 20 | 183-135/66 | Trial Cup, Ø 66 mm |
| 21 | 183-135/68 | Trial Cup, Ø 68 mm |
| 22 | 183-135/70 | Trial Cup, Ø 70 mm |

*on request, not part of the standard set configuration

184-110/07 Instrument Set 1 for BiMobile Dual Mobility System

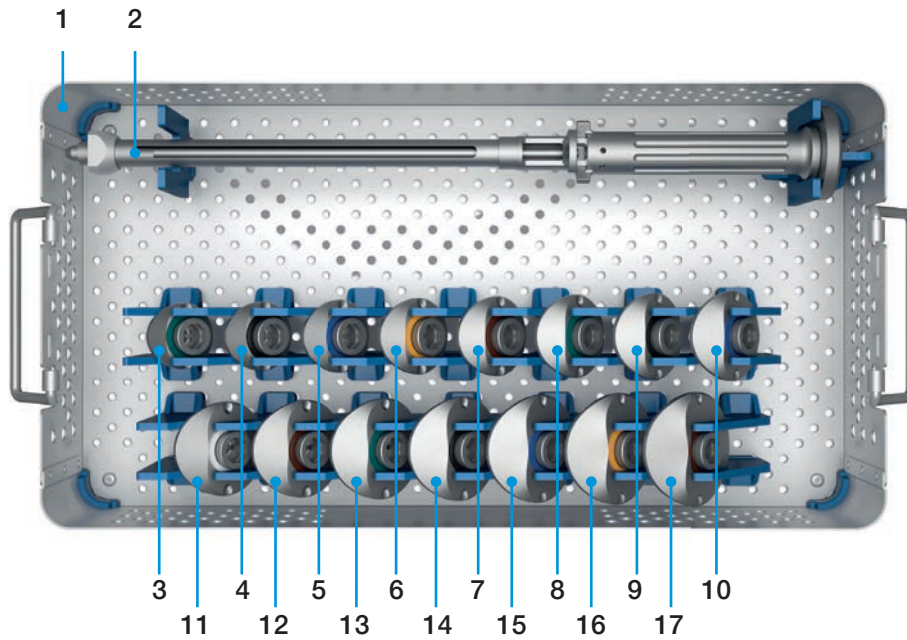

| | REF | Description |
|----|------------|-------------------------------------|
| 1 | 184-110/17 | Instrument Tray, empty |
| 2 | 184-334/00 | Impactor Handle |
| 3 | 184-354/42 | Impaction Expander, Ø 42 mm, green |
| 4 | 184-354/44 | Impaction Expander, Ø 44 mm, black |
| 5 | 184-354/46 | Impaction Expander, Ø 46 mm, blue |
| 6 | 184-354/48 | Impaction Expander, Ø 48 mm, yellow |
| 7 | 184-354/50 | Impaction Expander, Ø 50 mm, brown |
| 8 | 184-354/52 | Impaction Expander, Ø 52 mm, green |
| 9 | 184-354/54 | Impaction Expander, Ø 54 mm, black |
| 10 | 184-354/56 | Impaction Expander, Ø 56 mm, blue |
| 11 | 184-354/58 | Impaction Expander, Ø 58 mm, grey |
| 12 | 184-354/60 | Impaction Expander, Ø 60 mm, brown |
| 13 | 184-354/62 | Impaction Expander, Ø 62 mm, green |
| 14 | 184-354/64 | Impaction Expander, Ø 64 mm, black |
| 15 | 184-354/66 | Impaction Expander, Ø 66 mm, blue |
| 16 | 184-354/68 | Impaction Expander, Ø 68 mm, yellow |
| 17 | 184-354/70 | Impaction Expander, Ø 70 mm, brown |

184-110/02 Instrument Set 2 (Option 1) for BiMobile Dual Mobility System

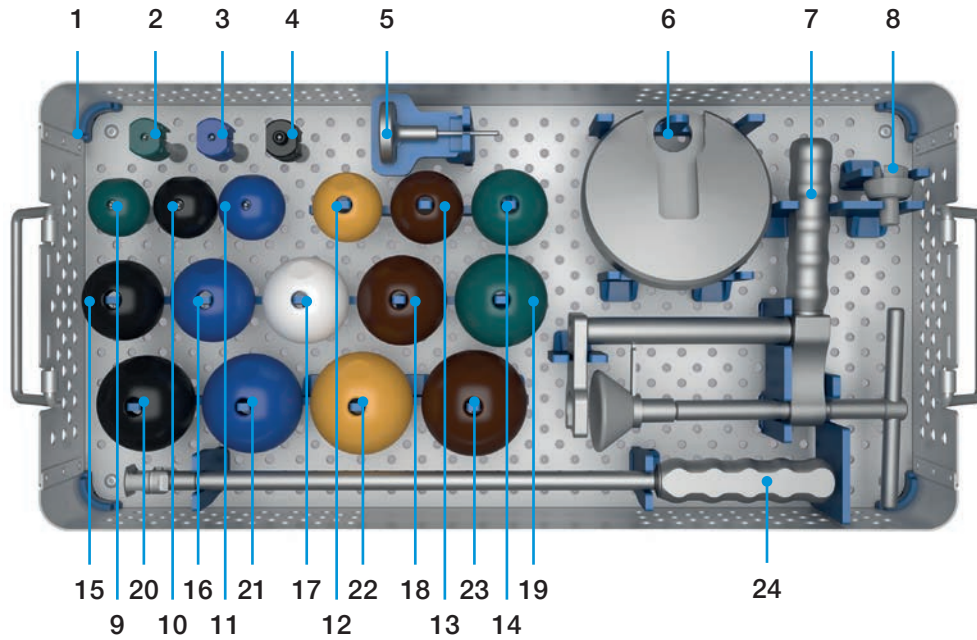

| | REF | Description |
|----|------------|---|
| 1 | 184-110/12 | Instrument Tray, empty |
| 2 | 106-020/01 | Plastic Trial Sleeve, size S, short, green |
| 3 | 106-020/02 | Plastic Trial Sleeve, size M, medium, blue |
| 4 | 106-020/03 | Plastic Trial Sleeve, size L, long, black |
| 5 | 15-1099 | Disassembly Support |
| 6 | 184-361/00 | Base |
| 7 | 184-360/00 | Press |
| 8 | 184-362/00 | Adapter Base for Prosthesis Heads |
| 9 | 184-320/42 | Trial Liner for Trial Sleeve, Ø 42 mm, green |
| 10 | 184-320/44 | Trial Liner for Trial Sleeve, Ø 44 mm, black |
| 11 | 184-320/46 | Trial Liner for Trial Sleeve, Ø 46 mm, blue |
| 12 | 184-320/48 | Trial Liner for Trial Sleeve, Ø 48 mm, yellow |
| 13 | 184-320/50 | Trial Liner for Trial Sleeve, Ø 50 mm, brown |
| 14 | 184-320/52 | Trial Liner for Trial Sleeve, Ø 52 mm, green |
| 15 | 184-320/54 | Trial Liner for Trial Sleeve, Ø 54 mm, black |
| 16 | 184-320/56 | Trial Liner for Trial Sleeve, Ø 56 mm, blue |
| 17 | 184-320/58 | Trial Liner for Trial Sleeve, Ø 58 mm, grey |
| 18 | 184-320/60 | Trial Liner for Trial Sleeve, Ø 60 mm, brown |
| 19 | 184-320/62 | Trial Liner for Trial Sleeve, Ø 62 mm, green |
| 20 | 184-320/64 | Trial Liner for Trial Sleeve, Ø 64 mm, black |
| 21 | 184-320/66 | Trial Liner, for Trial Sleeve, 66 mm, blue |
| 22 | 184-320/68 | Trial Liner for Trial Sleeve, Ø 68 mm, yellow |
| 23 | 184-320/70 | Trial Liner for Trial Sleeve, Ø 70 mm, brown |
| 24 | 106-007/00 | Handle for Plastic Trial Head/Liner |

184-110/03 Instrument Set 2 (Option 2) for BiMobile Dual Mobility System

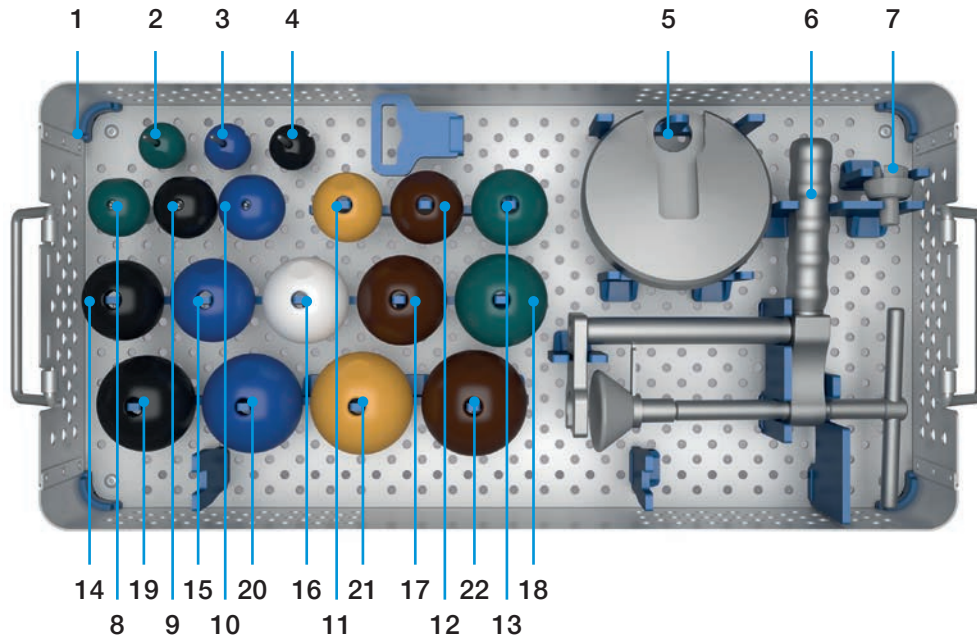

| | REF | Description |
|----|------------|---|
| 1 | 184-110/12 | Instrument Tray, empty |
| 2 | 175-928/11 | Plastic Trial Head, Ø 28 mm, size S, short, green |
| 3 | 175-928/12 | Plastic Trial Head, Ø 28 mm, size M, medium, blue |
| 4 | 175-928/13 | Plastic Trial Head, Ø 28 mm, size L, long, black |
| 5 | 184-361/00 | Base |
| 6 | 184-360/00 | Press |
| 7 | 184-362/00 | Adapter Base for Prosthesis Heads |
| 8 | 184-321/42 | Trial Liner, for Ø 28 mm Plastic Trial Heads, Ø 42 mm, green |
| 9 | 184-321/44 | Trial Liner, for Ø 28 mm Plastic Trial Heads, Ø 44 mm, black |
| 10 | 184-321/46 | Trial Liner, for Ø 28 mm Plastic Trial Heads, Ø 46 mm, blue |
| 11 | 184-321/48 | Trial Liner, for Ø 28 mm Plastic Trial Heads, Ø 48 mm, yellow |
| 12 | 184-321/50 | Trial Liner, for Ø 28 mm Plastic Trial Heads, Ø 50 mm, brown |
| 13 | 184-321/52 | Trial Liner, for Ø 28 mm Plastic Trial Heads, Ø 52 mm, green |
| 14 | 184-321/54 | Trial Liner, for Ø 28 mm Plastic Trial Heads, Ø 54 mm, black |
| 15 | 184-321/56 | Trial Liner, for Ø 28 mm Plastic Trial Heads, Ø 56 mm, blue |
| 16 | 184-321/58 | Trial Liner, for Ø 28 mm Plastic Trial Heads, Ø 58 mm, grey |
| 17 | 184-321/60 | Trial Liner, for Ø 28 mm Plastic Trial Heads, Ø 60 mm, brown |
| 18 | 184-321/62 | Trial Liner, for Ø 28 mm Plastic Trial Heads, Ø 62 mm, green |
| 19 | 184-321/64 | Trial Liner, for Ø 28 mm Plastic Trial Heads, Ø 64 mm, black |
| 20 | 184-321/66 | Trial Liner, for Ø 28 mm Plastic Trial Heads, Ø 66 mm, blue |
| 21 | 184-321/68 | Trial Liner, for Ø 28 mm Plastic Trial Heads, Ø 68 mm, yellow |
| 22 | 184-321/70 | Trial Liner, for Ø 28 mm Plastic Trial Heads, Ø 70 mm, brown |

optional

| | |
|------------|--|
| 132-922/01 | Plastic Trial Head, Ø 22 mm, size S, short, green |
| 132-922/02 | Plastic Trial Head, Ø 22 mm, size M, medium, blue |
| 184-322/42 | Trial Liner, for Ø 22 mm Plastic Trial Heads, Ø 42 mm, green |
| 184-322/44 | Trial Liner, for Ø 22 mm Plastic Trial Heads, Ø 44 mm, black |
| 184-322/46 | Trial Liner, for Ø 22 mm Plastic Trial Heads, Ø 46 mm, blue |

132-260/01 Instrument Set for LINK Acetabular Reamers

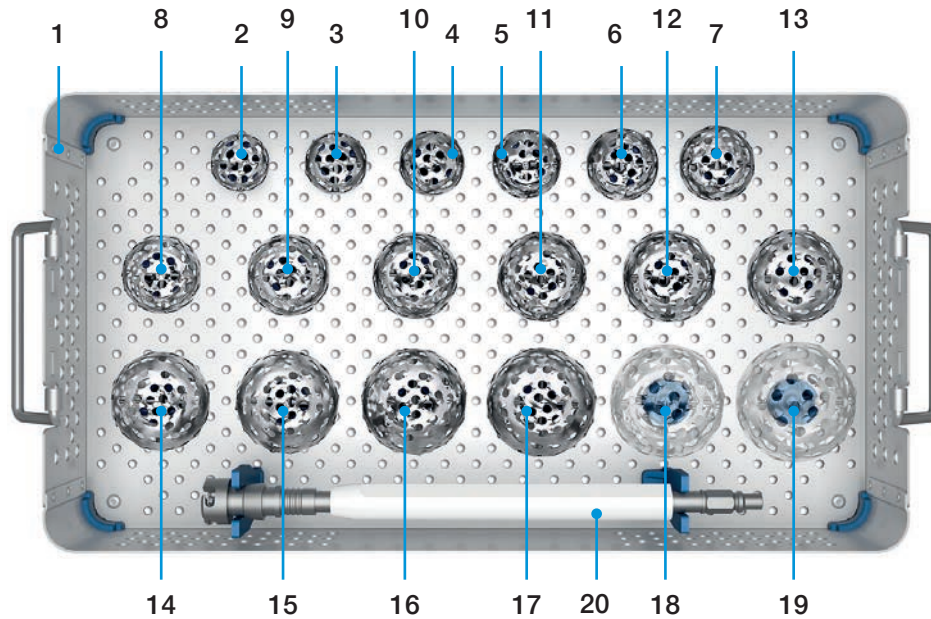

| | REF | Description |
|----|-------------|---|
| 1 | 132-260/10 | Instrument Tray, empty |
| 2 | 131-170/38 | Acetabular Reamer Head, Reamer-Ø 38 mm |
| 3 | 131-170/40 | Acetabular Reamer Head, Reamer-Ø 40 mm |
| 4 | 131-170/42 | Acetabular Reamer Head, Reamer-Ø 42 mm |
| 5 | 131-170/44 | Acetabular Reamer Head, Reamer-Ø 44 mm |
| 6 | 131-170/46 | Acetabular Reamer Head, Reamer-Ø 46 mm |
| 7 | 131-170/48 | Acetabular Reamer Head, Reamer-Ø 48 mm |
| 8 | 131-170/50 | Acetabular Reamer Head, Reamer-Ø 50 mm |
| 9 | 131-170/52 | Acetabular Reamer Head, Reamer-Ø 52 mm |
| 10 | 131-170/54 | Acetabular Reamer Head, Reamer-Ø 54 mm |
| 11 | 131-170/56 | Acetabular Reamer Head, Reamer-Ø 56 mm |
| 12 | 131-170/58 | Acetabular Reamer Head, Reamer-Ø 58 mm |
| 13 | 131-170/60 | Acetabular Reamer Head, Reamer-Ø 60 mm |
| 14 | 131-170/62 | Acetabular Reamer Head, Reamer-Ø 62 mm |
| 15 | 131-170/64 | Acetabular Reamer Head, Reamer-Ø 64 mm |
| 16 | 131-170/66 | Acetabular Reamer Head, Reamer-Ø 66 mm |
| 17 | 131-170/68 | Acetabular Reamer Head, Reamer-Ø 68 mm |
| 18 | 131-170/70* | Acetabular Reamer Head, Reamer-Ø 70 mm |
| 19 | 131-170/72* | Acetabular Reamer Head, Reamer-Ø 72 mm |
| 20 | 131-171B** | Straight Reamer Handle, Plastic Handle for Acetabular Reamer Heads, fittings optional |
| | 131-171/01 | Straight Reamer Handle, Plastic Handle for 131-171B - E |

* On request (not included in set configuration 132-260/01)

** How to order: 131-171E = with Jacobs Chuck fitting

| | | |
|----------|----------|--------------|
| | | |
| B | D | E |
| Hudson | AO | Jacobs Chuck |

132-260/02 Instrument Set for LINK Acetabular Reamers

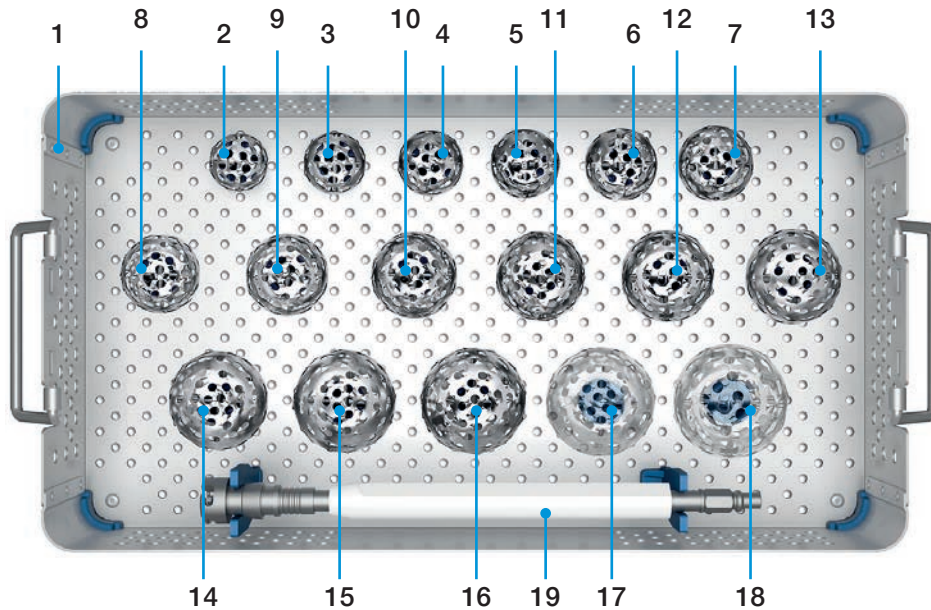

| | REF | Description |
|----|-------------|---|
| 1 | 132-260/11 | Instrument Tray, empty |
| 2 | 131-170/41 | Acetabular Reamer Head, Reamer-Ø 41 mm |
| 3 | 131-170/43 | Acetabular Reamer Head, Reamer-Ø 43 mm |
| 4 | 131-170/45 | Acetabular Reamer Head, Reamer-Ø 45 mm |
| 5 | 131-170/47 | Acetabular Reamer Head, Reamer-Ø 47 mm |
| 6 | 131-170/49 | Acetabular Reamer Head, Reamer-Ø 49 mm |
| 7 | 131-170/51 | Acetabular Reamer Head, Reamer-Ø 51 mm |
| 8 | 131-170/53 | Acetabular Reamer Head, Reamer-Ø 53 mm |
| 9 | 131-170/55 | Acetabular Reamer Head, Reamer-Ø 55 mm |
| 10 | 131-170/57 | Acetabular Reamer Head, Reamer-Ø 57 mm |
| 11 | 131-170/59 | Acetabular Reamer Head, Reamer-Ø 59 mm |
| 12 | 131-170/61 | Acetabular Reamer Head, Reamer-Ø 61 mm |
| 13 | 131-170/63 | Acetabular Reamer Head, Reamer-Ø 63 mm |
| 14 | 131-170/65 | Acetabular Reamer Head, Reamer-Ø 65 mm |
| 15 | 131-170/67 | Acetabular Reamer Head, Reamer-Ø 67 mm |
| 16 | 131-170/69 | Acetabular Reamer Head, Reamer-Ø 69 mm |
| 17 | 131-170/71* | Acetabular Reamer Head, Reamer-Ø 71 mm |
| 18 | 131-170/73* | Acetabular Reamer Head, Reamer-Ø 73 mm |
| 19 | 131-171B** | Straight Reamer Handle, Plastic Handle for Acetabular Reamer Heads, fittings optional |
| | 131-171/01 | Straight Reamer Handle, Plastic Handle for 131-171B - E |

* On request (not included in set configuration 132-260/02)

** How to order: 131-171E = with Jacobs Chuck fitting

| | | |
|----------|----------|--------------|
| | | |
| B | D | E |
| Hudson | AO | Jacobs Chuck |

Additional Instruments

Penetrating Drill

with depth stop, 150 mm
optional fittings

| REF | Drill Ø/mm |
|------------|------------|
| 130-311/35 | 3.5 |
| 130-311/50 | 5.0 |



| B | C | D | E |
|--------|--------|----|--------------|
| Hudson | Harris | AO | Jacobs Chuck |

Order example

- 130-311/35B = with Hudson fitting
- 130-311/35C = with Harris fitting
- 130-311/35D = with AO fitting
- 130-311/35E = with Jacobs Chuck fitting



130-311/05 Cement Hole Puncher

Accessories

X-ray Templates for LINK BiMobile Dual Mobility System
15 sheets, 110% actual size

| REF | X-ray templates |
|------------|---|
| 184-400/00 | for BiMobile Dual Mobility System, uncemented |
| 184-410/00 | for BiMobile Dual Mobility System, cemented |

Instructions for Cleaning and Maintenance

Specific instructions for instruments are available on request from info@linkbio.com



For more information please register for our LINK Media Library (link-ortho.com)

| |
|--|
| Specified Indications and Contraindications: |
| General Indications |
| Mobility-limiting diseases, fractures or defects of the hip joint or proximal femur which cannot be treated by conservative or osteosynthetic procedures |
| Indications |
| Primary and secondary coxarthrosis |
| Rheumatoid arthritis |
| Correction of functional deformities |
| Avascular necrosis |
| Femoral neck fractures |
| Revision after implant loosening dependent on bone mass and quality |
| Dislocation risks |
| Contraindications |
| Acute and chronic infections, local and systemic insofar as they compromise the successful implantation of a total hip prosthesis |
| Allergies to (implant) materials |
| Distinctive muscular-, nerve-, vascular or other diseases which put the affected limb at risk |
| Insufficient/inadequate bone mass or bone quality which prevents a stable anchorage of the prosthesis |

The device is intended for cemented and uncemented use.

INFORMATION:

These indications/contraindications refer to standard cases. The ultimate decision on whether or not an implant is suitable for a patient must be made by the surgeon based on his/her individual analysis and his/her experience.

INFORMATION:

Extra long head necks with a skirt should not be used. This may decrease the range of motion and may cause an impingement risk with the dual mobility liner.

Please note the following regarding the use of our implants:

1. Choosing the right implant is very important.

The size and shape of the human bone determines the size and shape of the implant and also limits the load capacity. Implants are not designed to withstand unlimited physical stress. Demands should not exceed normal functional loads.

2. Correct handling of the implant is very important.

Under no circumstances should the shape of a finished implant be altered, as this shortens its life span. Our implants must not be combined with implants from other manufacturers. The instruments indicated in the Surgical Technique must be used to ensure safe implantation of the components.

3. Implants must not be reused.

Implants are supplied sterile and are intended for single use only. Used implants must not be used again.

4. After-treatment is also very important.

The patient must be informed of the limitations of the implant. The load capacity of an implant cannot compare with that of healthy bone!

5. Unless otherwise indicated, implants are supplied in sterile packaging.

Note the following conditions for storage of packaged implants:

- Avoid extreme or sudden changes in temperature.
- Sterile implants in their original, intact protective packaging may be stored in permanent buildings up until the "Use by" date indicated on the packaging.
- They must not be exposed to frost, dampness or direct sunlight, or mechanical damage.
- Implants may be stored in their original packaging for up to 5 years after the date of manufacture. The "Use by" date is indicated on the product label.
- Do not use an implant if the packaging is damaged.

6. Traceability is important.

Please use the documentation stickers provided to ensure traceability.

7. Further information on the material composition is available on request from the manufacturer.

Follow the instructions for use!

Waldemar Link GmbH & Co. KG, Hamburg

All content in this catalog, including text, pictures and data, is protected by law. Every instance of use, whether in part or in whole and which is not permitted by law, is subject to our prior consent. In particular, this applies to the reproduction, editing, translation, publishing, saving, processing, or passing on of content stored in databases or other electronic media and systems, in any manner or form. The information in the catalogs is solely intended to describe the products and does not constitute a guarantee.

The Surgical Technique described has been written to the best of our knowledge and belief, but it does not relieve the surgeon of his/her responsibility to duly consider the particularities of each individual case.

Products shown in this document may not be available in your country. The product availability is subject to the approval and/or registration regulations of the respective country. Please contact Waldemar Link GmbH & Co. KG if you have questions about the availability of LINK products in your country.

Waldemar Link GmbH & Co. KG and/or other corporate affiliated entities own, use or have applied for the following trademarks in many jurisdictions: LINK, BiMobile, SP II, Modell Lubinus, E-Dur, EndoDur, T.O.P. II, BetaCup, CombiCup PF, CombiCup SC, CombiCup R, MobileLink, C.F.P., LCU, SP-CL, LCP, MIT-H, Endo-Model, Endo-Model SL, MP, MEGASYSTEM-C, GEMINI SL, SPAR-K, LCK, Link OptiStem, HX, TiCaP, X-LINKed, PorAg, LINK PorEx, BiPorEx, PorEx-Z, TrabecuLink, Tilastan, customLINK, RescueSleeve, Stactip, VACUCAST.

Other trademarks and trade names may be used in this document to refer to either the entities claiming the marks and/or names or their products and are the property of their respective owners.

This publication is intended for distribution in the U.S. only.